

THE MELTING PROCESS OF ACETYLSALICYLIC ACID SINGLE CRYSTALS

G. L. Perlovich^{1,2} and A. Bauer-Brandl^{1}*

¹Universitetet i Tromsø, Institutt for farmasi, Breivika, N-9037 Tromsø, Norway

²Institute of Solution Chemistry, Russian Academy of Sciences, Ivanovo, Russia

(Received September 4, 2000, in revised form November 10, 2000)

Abstract

Crystallisation is generally regarded as a nucleation – growth mechanism of a solid phase and often studied using thermochemical methods. The present work postulates an analogy to melting processes, looking at melting as nucleation – growth of a liquid phase. The melting process of acetylsalicylic acid single crystals was investigated by DSC measurements under isothermal conditions. The fraction of material molten after a certain time period, $\alpha(t)$, was calculated by integrating the DSC curves. The resulting kinetic curves were fitted using the Avrami–Erofeev equation: $-\ln(1-\alpha)=kt^n$, where parameter n was analysed. According to established methods, functions $I(2')=[t(2')]/[t(2')+t(3')]100\%$ and $I(3')=[t(3')]/[t(3')+t(2')]100\%$ were introduced, where $t(2')$ and $t(3')$ is the absolute time of consumption two- and three-dimension nuclei growth, respectively. Applying correlation analysis, relationships between two- or three-dimensional growth and the independent variables describing the single crystals (for strictly definite trajectories into the space of sizes) were found. Particular correlations were: a) Two-dimensional growth is a function of the total surface area of the crystal, S , and of the surface area of the (ac)-face, S_{ac} ; b) Three-dimensional growth is a function of S/M (where M is the mass of the single crystal). It is also a function of S_{ac}/M and of S . The obtained experimental data are explained by the 'layer' structure of crystals of acetylsalicylic acid.

Keywords: acetylsalicylic acid, Avrami–Erofeev equation, isothermal melting process, single crystal, two- and three-dimension growth nuclei

Introduction

Acetylsalicylic acid (*ASA*, Aspirin) has already been studied with regard to crystal structure [1–8] and a correlation between habit and solubility in different solvents has been found [9–12]. Energetic non-equivalence of the different faces of single crystals in the dissolution process has been proposed [9]. Moreover, a habit parameter $(S_{ac}+S_{bc})/S_{ab}$ (where S_{ac} , S_{bc} , S_{ab} are the surface areas of the corresponding faces of single crystals) has been introduced by the same authors [9] in order to describe the dis-

* Author to whom correspondence should be addressed. E-mail: annetteb@farmasi.uit.no

solution behaviour of single crystals. Crystallisation and crystal growth of single crystals was first studied in detail by Stranski [13]. A crystallisation process starts with solid phase nucleation followed by crystal growth either in two or in three dimensions. These two mechanisms of progression of crystallisation can be distinguished from each other by their differences in over-all kinetics and measured thermochemically [15]. In the present work, kinetic aspects of the melting process of acetylsalicylic acid single crystals are studied. It is hypothesised that the melting process can be described similarly to crystallisation assuming that nucleation of the liquid phase is followed by growth of the liquid phase in two or three dimensions respectively. The relationship between the geometry of the crystals investigated and the relative time consumption of two- and three-dimensional growth of the liquid phase is particularly studied.

Material and methods

Aspirin (analytical grade) was from Norsk Medisinaldepot (Oslo, Norway). Ethanol, extra pure grade (99.6% v/v, maximum water content 0.4%) was used for crystallisation.

Single crystals of acetylsalicylic acid were obtained by slow evaporation of the solvent from a saturated ethanolic solution. Prior to measurements, single crystals were removed from the mother liquor. Upon washing in pure ethanol, the crystals were thoroughly dried under vacuum and stored under moisture-free conditions.

The size of crystals was measured with a relative accuracy of $\pm 1\%$ in a Zeiss 'Axioskop' interference contrast microscope (Carl Zeiss, Oberkochen, Germany) using the method described by Watanabe *et al.* [9].

Thermal properties of *ASA* single crystals were measured using a Perkin Elmer Pyris 1 DSC differential scanning calorimeter (Perkin Elmer Analytical Instruments, Norwalk, Connecticut, USA). The DSC was calibrated with indium from Perkin Elmer (P/N 0319-0033). The value of the determined enthalpy of fusion corresponded to -28.48 J g^{-1} (reference value -28.45 J g^{-1}). The melting point was $156.5 \pm 0.1^\circ\text{C}$.

ASA crystals were heated to a temperature of $134.00 \pm 0.01^\circ\text{C}$ at a rate of 10 K min^{-1} using closed standard aluminium sample pans. The temperature was held constant during 30 min in an atmosphere of flowing dry nitrogen gas of high purity (20 ml min^{-1}). After the DSC experiment, the compound was analysed for decomposition products by the method described by Borcka [14] using an UV spectrophotometer (Hitachi U-2001, Hitachi, Tokyo, Japan). No traces of salicylic acid were found.

In order to study kinetics of the melting process under isothermal conditions, Avrami–Erofeev equation [15] was used:

$$-\ln(1-\alpha) = kt^n \quad (1)$$

where α is the fraction of material molten until time t :

$$\alpha = \Delta_{\text{fus}}H(t) / \Delta_{\text{fus}}H_{\text{sum}} \quad (2)$$

$\Delta_{\text{fus}}H(t)$ is the enthalpy of fusion until time t ; $\Delta_{\text{fus}}H_{\text{sum}}$ is the total enthalpy of fusion.

The index n in Eq. (1) was determined from the slope of the plot of $\ln[-\ln(1-\alpha)]$ vs. $\ln(t)$ according to the theory on nucleation-growth during crystallisation [15].

Each plot can be divided into several stages: a) nucleation under the power law ($n=1.24$); b) two-dimensional nucleus growth ($n=2$) with a constant number of nuclei (the nucleation rate is equal zero); c) three-dimensional nucleus growth ($n=3$) with a constant number of nuclei (the nucleation rate is equal zero); d) a last short stage ($n \gg 3$) which is not easily interpretable. The regions of the curves where the two- and the three-dimension nuclei growth respectively takes place ($n=2$ and $n=3$, respectively) were determined by means of the least-squares method: the statistical significance of each experimental data point for the accuracy of the calculation of the value n was calculated. Since the total time consumption for stages a) and d) is much smaller than the respective time consumption of stages b) and c), the correlation functions were chosen as follows:

$$I(2') = \frac{t(2')}{t(2') + t(3')} 100\% \quad (3)$$

$$I(3') = \frac{t(3')}{t(2') + t(3')} 100\% \quad (4)$$

where $t(2')$, $t(3')$ are the total time consumption of two- and three-dimension nuclei growth, respectively.

Results and discussion

The surface area distributions of the planes of the particular single crystals investigated are presented in Fig. 1.

A selection of typical kinetic curves is represented as an example in Fig. 2. The regions of two- and three-dimensional growth respectively are marked and the fitted

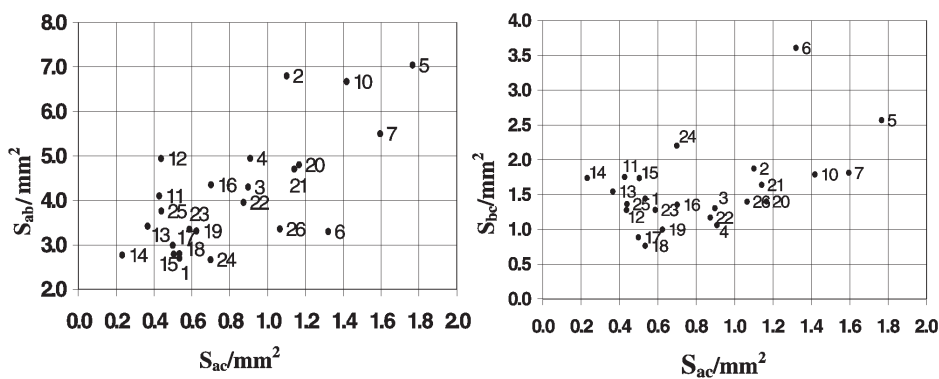

Fig. 1 Distribution of surface areas of 26 planes of the single crystals investigated

curves are shown as well. From Fig. 2, a correlation between the kinetics of phase transition and the size of the single crystals can be suspected.

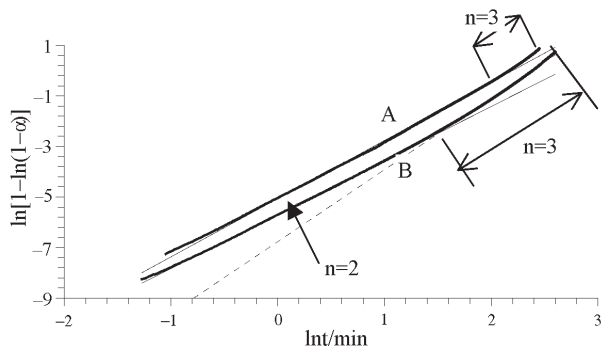

Fig. 2 Typical kinetic curves of the single crystals of acetylsalicylic acid. The size (in mm) of A: $a=1.50$; $b=2.90$; $c=0.467$ and B: $a=0.900$; $b=3.10$; $c=0.560$

The *ASA* crystal structure has already been described sufficiently in the literature [6, 7]. Acetylsalicylic acid crystallises in the monoclinic space group $P2_1/c$. A unit cell contains $Z=4$ molecules. Parameters of the unit cell are as follows [6] {[7]}: $a=11.446(13)$ { $11.430(1)$ } Å; $b=6.596(6)$ { $6.591(1)$ } Å; $c=11.388(9)$ { $11.395(2)$ } Å; $\beta=95^\circ 33' \pm 2'$ { $95.68(1)^\circ$ }. The crystal is composed of centrosymmetric dimers, where two molecules are linked together by a pair of hydrogen bonds between their respective carboxyl groups. Moreover, the structure of a crystal can be regarded as a layer system oriented in parallel to plane (001). Each of these layers consists of dimers arranged in parallel to each other like ‘books on a shelf’. There are two types of layers: one type consists of dimers which form an angle of 50° with the (001) plane whereas the other dimers form an angle of -125° . The dimers belonging to different layers enclose an angle of about 60° .

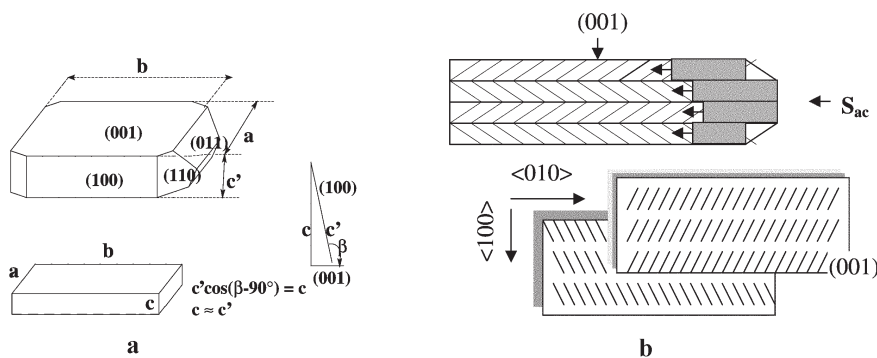

Fig. 3 Crystallographic planes of single crystal of *ASA* (a). The scheme of layers structure of single crystal (b)

A schematic picture of a single crystal of *ASA* and some of its crystallographic planes are presented in Fig. 3a. The layers of the two- or three-dimensional structure within a single crystal is schematically shown in Fig. 3b. The respective angles between the planes of the single crystal and the planes of the *ASA* dimers are summarised in Table 1.

Table 1 Angles between planes of acetylsalicylic acid dimers and the crystallographic planes of crystal

N dimer ^a	Crystallographic plane	Angle
1	(100)	55°
2	(100)	132° (48°)
1	(010)	60°
2	(010)	120° (60°)
1	(001)	50°
2	(001)	125° (55°)
1	(011)	40°
2	(011)	109° (71°)
1	(110)	50°
2	(110)	105° (75°)
1 ^b	2	60°

^aThe dimers belonging to different layers (1 or 2);

^bThe angle between dimers belonging to different layers

Therefore, if the single crystal is considered as a system of layers, sizes a and b determine a surface area, whereas size c determines the number of layers.

In order to analyse the considered functions, two trajectories in the space of surface areas (Fig. 1) were selected. This procedure is based on the fact that the investigated functions may be more sensitive to changes in crystal sizes lying on them. It should be noted that the same regularities as described below are observed for other trajectories as well. The trajectories chosen can be characterised by the following properties (in addition to the complicated equations describing the relationship between surface area of crystal planes): the crystals belonging the first trajectory (1 : $S_{bc}=0.88S_{ac}+0.44$) have approximately the same size b ; whereas the crystals belonging the second one (2 : $S_{bc}=-1.94S_{ac}+2.20$) have the same values $(ab)/S$.

Correlation of the function $I(2')$ and total surface area of crystal, S , and surface area of face (ac), S_{ac} , are listed in Figs 4 and 5, respectively.

The relative time consumption of two-dimension nuclei growth, $I(2')$, increases with increasing total surface area of the crystal S (Fig. 4). This is not surprising, and indicates that increasing total surface area increases the probability of two-dimensional nucleus growth. Furthermore, function $I(2')$ is also sensitive to changes of the variable S_{ac} . Such correlation may be explained by several reasons: firstly, this fact is a consequence of the geometry of the single crystal, which elongates along direction

b (i.e. a slight change both in sizes a (δa) and c (δc) leads to an essential change of the total surface area because of addition of relatively big values ($b\delta a$) and/or ($b\delta c$). In confirmation of this fact, the rate of change of $I(2)$ of the 2-trajectory is bigger than for the 1-trajectory. Crystals belonging to the one or the other trajectory differ in the average values of size b (1 – 2.6 mm, 2 – 3.3 mm). Secondly, increasing c leads to an increased number of layers and consequently an increased number steps (if a ‘steps’ mechanism of two-dimensional growth is proposed, as is shown in Fig. 3b). Thirdly, face (ac) of a single crystal consists of several crystallographic planes (011), (110), ($1\bar{1}0$), ($\bar{1}10$) (Fig. 3a). The planes of dimers form angles between each other and these crystallographic planes, which are more favourable for growth of nuclei of liquid phase lengthways the layer than across. Probably, the surface (ac) initiates nucleation and two-dimension nuclei growth or, at least, is preferable for these processes compared to the other faces.

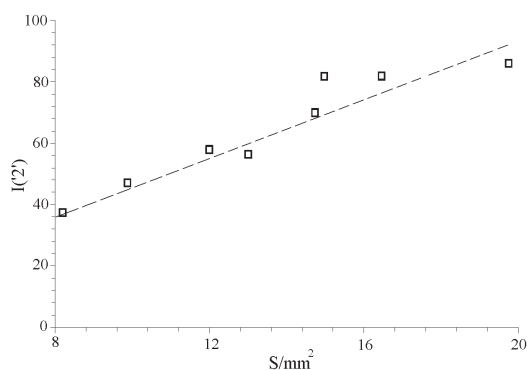

Fig. 4 Plot of function $I(2)$ vs. total surface area of single crystal, S , for strictly definite trajectory into the space of sizes: $S_{bc}=0.88S_{ac}+0.44$

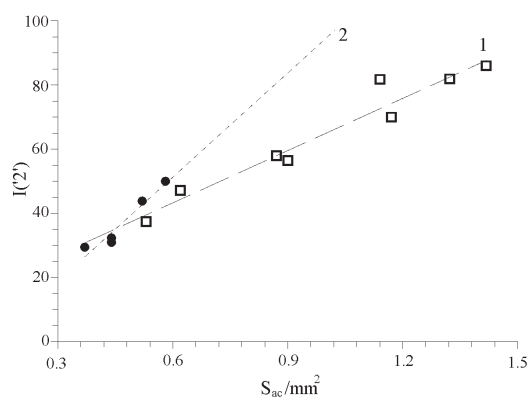

Fig. 5 Plot of function $I(2)$ vs. surface area of grain (ac) of single crystal, S_{ac} , for strictly definite trajectories into the space of sizes: $S_{bc}=0.88S_{ac}+0.44$ (1); $S_{bc}=-1.94S_{ac}+2.20$ (2)

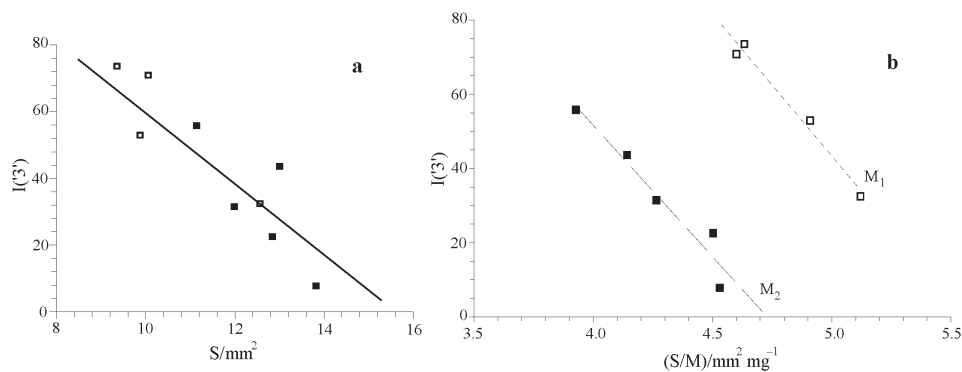

Fig. 6 Correlation of function $I(3')$ vs. S (a) and S/M (b) for crystals having a similar mass ($M_1=2.1\pm 0.1$ mg and $M_2=2.9\pm 0.1$ mg)

In order to determine general rules of the behaviour of three-dimensional growth, various independent variables were used. A relationship between $I(3')$ and S for two groups of single crystals having a similar mass is presented in Fig. 6a. The same crystals are listed in Fig. 6b (same symbols) in the form of a relationship between $I(3')$ and S/M (where M is the mass of the single crystal). The variable S/M can be interpreted as a ratio of the total surface area and the volume of a single crystal, since the volume V equals M/ρ (where ρ is the density of the crystal). For single crystals having similar mass (volume), function $I(3')$ decreases with increasing total surface. Moreover, the correlation line which corresponds to crystals with larger mass (volume) is situated lower than the analogous curve for crystals with smaller mass (volume). Separating the correlation curves in Fig. 6a into two groups of correlations (Fig. 6b), it can be argued that variable S/M describes the mechanism of three-dimensional growth in a better way.

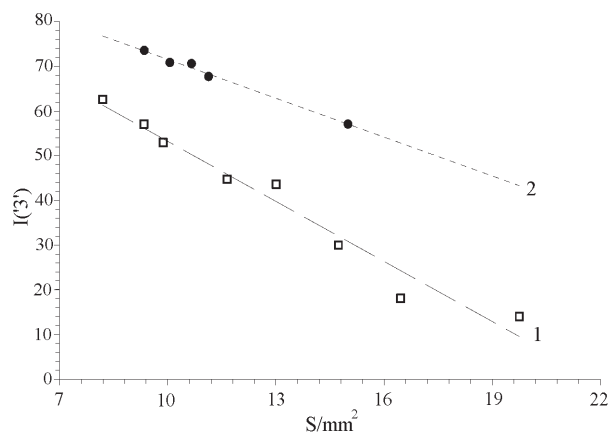

Fig. 7 Plot of function $I(3')$ vs. total surface area of single crystal, S , for strictly definite trajectories into space of sizes (1 and 2 as in Fig. 5)

The function $I'(3')$ correlates with total surface area, S , as was already found for $I'(2')$ (Fig. 7). However, in contrast to two-dimensional nuclei growth (Fig. 4), the relative time consumption for three-dimensional nuclei growth decreases with increasing S , which is not unexpected.

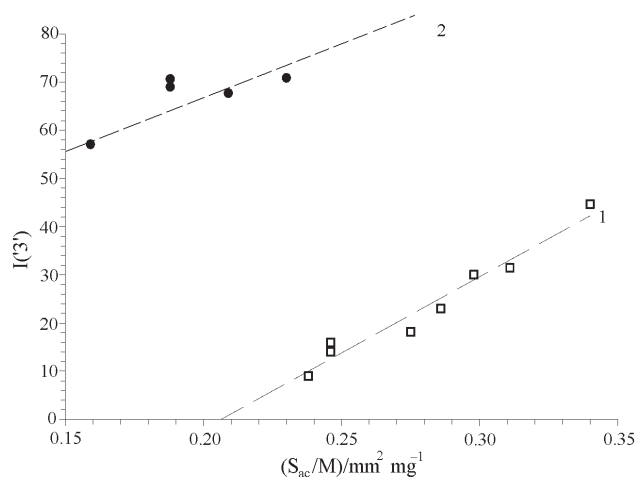

Fig. 8 Plot of function $I'(3')$ vs. S_{ac}/M for strictly definite trajectories into space of sizes (1 and 2 as in Fig. 5)

A relationship between $I'(3')$ and S_{ac}/M is depicted in Fig. 8. As can be seen from this figure, $I'(3')$ increases with S_{ac}/M , whereas it decreases with total surface area S/M (Fig. 6b). Therefore, the surface (ac) plays an outstanding role in the melting process of a single crystal of acetylsalicylic acid. Presumably, the surface (ac) very sensitively promotes not only nucleation and two-dimensional nuclei growth, but also the 'switching' of this process towards three-dimensional nuclei growth. Furthermore, it is interesting to note that Watanabe *et al.* [9] emphasised different properties of this particular crystal surface in the dissolution behaviour of *ASA*. In order to explain differences of the dissolution constants in various solvents, they introduced a so-called 'habit parameter', which represents the ratio of the area of the (001) plane and the approximate sum of the surface areas of the remaining faces. However, due to a small number of experiments, they could not analyse the observed relationship more precisely.

Conclusions

The Avrami–Erofeev equation can be applied both to crystallisation and to describe the melting process of single crystals of acetylsalicylic acid. Analysis of thermochemical kinetic curves reveals that the respective time consumption of two- and three-dimensional growth of the liquid phase is sensitive to geometry (sizes, habit) of a single crystal.

The relative time consumption of two-dimensional nuclei growth, $I(2')$, increases with increasing both the total surface area of crystals S and the surface area of face (ac).

The relative time consumption of three-dimensional nuclei growth, $I(3')$, however, decreases with increasing total surface, S . For single crystals of similar mass (volume), function $I(3')$ decreases with increasing S/M and increases with increasing surface area of face (ac).

Results indicate that the observed relationships are caused by non-equivalent energetic positions of ASA dimers in the crystal, which has a 'layer' structure with different angles between the surface of the respective planes of the single crystal. Face (ac) plays an outstanding role for the melting process.

References

- 1 R. Niini, *Z. Krist.*, 79 (1931) 532.
- 2 H. Suzuki, I. Keimatsu and K. Ito, *J. Pharmac. Soc. Japan*, 53 (1933) 903.
- 3 S. Watanabe and A. Watanabe, *Proc. Imp. Acad. (Tokyo)*, 11 (1935) 379.
- 4 S. Kozu and K. Takane, *Proc. Imp. Acad. (Tokyo)*, 11 (1935) 381.
- 5 I. Nitta and T. Watanabe, *Sci. Papers Inst. Phys. Chem. Research. (Tokyo)*, 31 (1937) 125.
- 6 P. J. Wheatley, *J. Chem. Soc. Suppl.*, 6 (1964) 6036.
- 7 Y. Kim, K. Machida, T. Taga and K. Osaki, *Chem. Pharm. Bull.*, 33 (1985) 2641.
- 8 N. Masaki, K. Machida, H. Kado, K. Yokoyama and T. Tohda, *Chem. Pharm. Bull.*, 39 (1991) 1899.
- 9 A. Watanabe, Y. Yamaoka and K. Takada, *Chem. Pharm. Bull.*, 30 (1982) 2958.
- 10 H. Bundgaard, *J. Pharm. Pharmac.*, 26 (1974) 535.
- 11 J. Glasby and K. Ridgway, *J. Pharm. Pharmac.*, 20, Suppl. (1968) 94S.
- 12 G. Torrado, S. Fraile, Sus. Torrado and San. Torrado, *Int. J. Pharm.*, 166 (1998) 55.
- 13 I. N. Stranski, *Z. Phys. Chem.*, 1 (1928) 136.
- 14 L. Borka, *Acta Pharm. Suecica*, 9 (1972) 115.
- 15 J. Šesták, *Thermophysical Properties of Solids. Their Measurements and Theoretical Thermal Analysis*. Moscow, Mir 1987, p. 456.